

Review Article

Peter Hartmann*

Optical glass: standards – present state and outlook

DOI 10.1515/aot-2015-0047

Received October 26, 2015; accepted November 9, 2015

Abstract: In 1996, the international organization for standardization ISO started the standards series ISO 10110 specifying indications in drawings of optical elements. Three parts cover material properties: part 2 (stress birefringence), 3 (bubbles and inclusions), and 4 (inhomogeneity and striae). Customers used to just send optical element drawings to glass manufacturers often leading to uncertainty, overspecification, and delivery problems. The raw glass standard ISO 12123 of 2010 allows direct addressing of raw glass specifications. Harmonizing ISO 10110 with ISO 12123 and progress in inspection methods require updating of the material specifying parts. A new part 18 containing all properties is under preparation and is meant to replace parts 2–4. ISO 12123 will be amended by introducing definitions for relative partial dispersions and reference normal lines and grade denominations for tolerance ranges. The working draft ISO/WD 10110 part 18 extends indication possibilities to allow relating to ISO 12123 while ensuring backward compatibility. Default optical glass quality and direct specification of raw glass simplify tolerancing considerably. Annexes support selection of appropriate quality classes referring to optical element size categories. Test and inspection standards on chemical resistances, hardness, stress birefringence, and optical homogeneity will be maintained. Standards for water resistance, refractive index, and striae inspection are being prepared.

Keywords: inspection standards; ISO 10110; ISO 12123; measurement standards; specification standards.

1 Introduction

National standards on optical glass exist since long time, e.g. the US American military standard MIL-G-174 ‘Military Specification Glass, Optical’ of 1963 or the German standard DIN 58927 ‘Optical glass, terms of delivery’ of 1970, the British standard BS 4301, the French standard NF S 10 – 001 to 004, and the Japanese JOGIS standards. An international standard did not exist until 2010 when ISO 12123 ‘Specification of raw optical glass’ was published. Since 1996, the standard series ISO 10110 specifies indications in drawings of optical elements. Parts 2, 3, and 4 relate to material requirements on optical elements. In daily practice, many misunderstandings arose because the requirements on the elements were directly transferred to the optical raw glass [1]. For some glass properties, this seemed to be possible at first glance. Optical homogeneity (part 4), stress birefringence (part 2), and bubbles and inclusions (part 3) did not show obvious obstacles taking them from optical elements and specifying them for strip glass, block glass, or pressings. With striae (part 4), critical users already noticed a difficulty. The area share covered by striae can only be checked at the very finished element and not at the raw glass item. The direct transfer of the other properties leads to overspecification of the raw glass and, consequently, to high costs or to delivery problems. ISO 12123 contains an annex providing recommendations for avoiding overspecification. For further improvement, subcommittee SC 1 of the ISO technical committee TC 172 decided to change ISO 10110 by replacing parts 2, 3, and 4 with part 18 comprising all properties in one standard and also providing an explanatory annex. This standard is still in the draft stage.

Additionally, there is a systematic process ongoing to publish the inspection standards related to the specified quantities. Only for the measurement method of stress birefringence a standard existed (ISO 11455; 1995), until in 2014, ISO published ISO 17411 ‘Test method for homogeneity of optical glasses by laser interferometry’. Other standards on optical glass refer to chemical resistance determination and classification and the standards for wider application

*Corresponding author: Peter Hartmann, SCHOTT AG, Advanced Optics, Hattenbergstraße 10, Mainz 55122, Germany, e-mail: peter.hartmann@schott.com

beyond optical glass such as ISO 7884-8 ‘Transformation temperature’ and ISO 9385 ‘Knoop hardness’.

2 Optical glass standardization work in the International Organization for Standardization ISO

Almost 300 technical committees develop ISO standards in expert groups, see Figure 1. The technical committee TC 172 ‘Optics and Photonics’ operates seven subcommittees. Subcommittee SC 1 is responsible for fundamental standards, subcommittee SC 3 for optical materials and components. The remaining subcommittees deal with optical systems and instruments. For optical glass, mainly two working groups are important: Working group WG 2 of subcommittee SC 1 ‘Preparation of drawings for optical elements and systems’, which is the owner of the ISO 10110

series and working group WG 1 of subcommittee SC3 ‘Raw optical glass’ responsible for ISO 12123 and the raw glass inspection standards.

3 Specification standards related to optical glass

3.1 Overview

Specification and definition standards related to optical glass, which are valid or presently in preparation are (see Table 1):

ISO 9802 provides terms and definitions for properties of raw optical glass and related manufacturing processes in four languages in parallel: English, French, Russian, and German.

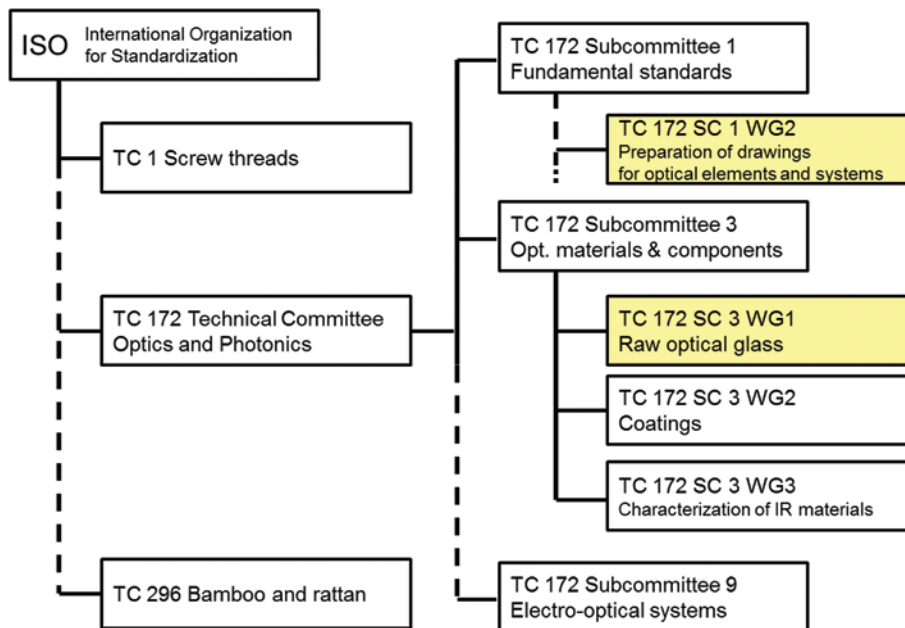

Figure 1: Organization of optical glass-related standard development.

Table 1: Specification and definition standards related to optical glass.

ISO 9802	Raw optical glass – vocabulary
ISO 10110 – 2	Material imperfections – stress birefringence
ISO 10110 – 3	Material imperfections – bubbles and inclusions
ISO 10110 – 4	Material imperfections – inhomogeneity and striae
ISO/WD 10110 – 18	Preparation of drawings for optical elements and systems – Part 18: Material imperfections – stress birefringence, bubbles, and inclusions Homogeneity and striae (working draft)
ISO 12123	Specification of raw optical glass

All standard titles except that of ISO 9802 begin with ‘Optics and photonics’.

ISO 10110 – 2 Stress birefringence gives only a definition and the indication in the drawing. Typical limit values for specific applications are listed in the annex. ISO 10110 – 3 Bubbles and inclusions provide definitions and the indication in the drawing. It introduces the grade number A, the square root of the projected area, allowing easier subdivision into smaller bubbles. Again, there is no set of tolerance limits given in the regulation section.

ISO 10110 – 4 Inhomogeneity and striae. Additionally, to the definitions and indications, this standard contains quality classes for both properties. This is because they both are a measure of variations of the refractive index across the aperture of the optical element. Inhomogeneity refers to spatial periods of longer ranges from several millimeters upward the striae to short range periods below 1 mm. Their effects in optical images and their inspection methods differ from each other, however.

ISO/WD 10110-18 is meant as replacement of parts 2, 3, and 4.

ISO 12123 provides a set of tolerance ranges for the same properties as treated in the ISO 10110 material specification parts and, additionally, for the refractive index, its variation in delivery lots, and for the Abbe number, which characterizes dispersion in a first approximation (see Table 2).

3.2 Definitions

Most standards contain a clause called ‘terms and definitions’ [http://www.iso.org/iso/home/standards_development/resources-for-technical-work.htm]. It is optional, but it is useful to have definitions of important quantities used in a standard directly available. Unfortunately, it happens quite often in writing a new standard

that quantities are defined once again, even though they have been defined already in other standards. This can lead to some confusion. In order to avoid this, a cross check should be made at the ISO online browsing platform [<https://www.iso.org/obp/ui/>]. It provides a list of already existing definitions together with the source standards.

If a new definition has to be formulated, care should be taken to use if ever possible a physical quantity with a known objective measurement method. The best choice is if it can be qualified according to ISO 5725 ‘Accuracy (trueness and precision) of measurement methods and results’.

It is preferable to join the mainstream philosophy for definitions. The world of optics has been developed quite separate from other technical fields such as mechanical or electrical engineering. In the past, for example, form tolerances have been defined quite differently from those used in mechanical engineering. The elaborate standard ISO 1101 specifies geometrical tolerancing with a consequent philosophy using distances of ideal mathematical elements such as straight lines or flat faces. It can be used also in optics. SCHOTT successfully introduced the spherical profile tolerance for the meniscus surfaces of large astronomical mirror blanks.

If possible, new standards should contribute to convergence of different technical fields. This will ease communication especially as the fields have already approached each other and will continue to do so. An example of this convergence is the use of ‘homogeneity’ instead of ‘inhomogeneity’ in ISO 12123. The ideal ‘homogeneity’ is zero variation of the refractive index. It is directly related to ideal flatness, the zero height variation of the transmitted wavefront. Admittedly, definitions in ISO 12123 are not totally puristic in their philosophy. In principle, the striae should be called short-range optical homogeneity and stress birefringence optical polarization homogeneity.

Table 2: Specification characteristics of ISO 12123:2010.

International Standard ISO 12123 Optics and Photonics – Specification of raw optical glass	
ISO 12123 – characteristic	Specification steps
Refractive index	±20, 10, 5, 3, 2×10^{-4}
Refractive index – lot variation	±30, 10, 5, 2×10^{-5}
Dispersion – Abbe number	±0.8, 0.5, 0.3, 0.2%
UV cutoff 80/10/color code	Only definition – no tolerances
Opt. homogeneity	100, 40, 10, 4, 2, 1×10^{-6}
Striae	60, 30, 15, 10 nm per 50 mm optical path length
Bubbles and inclusions: Cross section per test volume	0.5, 0.25, 0.1, $0.03 \text{ mm}^2/100 \text{ cm}^3$
Bubbles and inclusions: Number per volume	140, 70, 30, $10/\text{mm}^2$
Stress birefringence	>20, 20, 12, 6, 4, 2 nm/cm

4 ISO 12123 – The specification standard for raw optical glass

Five p-member countries have converted this standard to national standard or have announced to do this in the near future: France, Germany, Republic of Korea, USA, and Romania. P-members are countries, which have expressed interest in the development of standards of a subcommittee by naming an expert actively participating in the development process. The vote on the occasion of the systematic review occurring 5 years after the publication of the standard resulted in keeping the standard with the obligation to revise it.

The changes to be realized in the next version of ISO 12123 are

1. Introduction of standard reference lines for relative partial dispersions,
2. Grade indications for the tolerance ranges of all characteristics and
3. Some corrections and supplements resulting from expert comments resulting from the systematic review.

4.1 Standard normal lines for relative partial dispersions

In springtime 2015, experts in Japan and independently also from Germany realized an inconsistency in optical glass data quoted in data sheets of different glass manufacturers. The deviations of the relative partial dispersion $P_{g,F}$ from the normal line of glass types considered to be almost identical in chemical composition differed considerably larger among each other than the relative partial dispersion $P_{g,F}$ values themselves. For a common normal line serving as reference, this is not to be expected. A thorough research led to the conclusion that the reason lies in different definitions of the normal lines used by the glass manufacturers. Even though all manufacturers use the same glass types for the line definition, the crown glass K7 and the flint glass F2 (glass types names according to SCHOTT denominations), the dispersion curves of these glass types vary partly strongly [2].

In the course of the revision of ISO 12123, it has been proposed to incorporate definitions of partial dispersion, relative partial dispersion, and deviation of the relative partial dispersion. The normal lines will be derived from dispersion curves for K7 and F2 using the Sellmeier six-parameter equation [3, 4]. In order to obtain most accurate parameters, the refractive index data from the widest possible spectral range are used from the UV transmission edge up to 2.3 μm in the IR region. The prism goniometer method

employed provides measurement uncertainty of about 1×10^{-6} for the refractive index [5]. The refractive index at the most important and mostly used reference wavelength will be given explicitly and with seven digits precision to avoid rounding errors in early stages of calculations.

Another observation was that there is no standard set of relative partial dispersions and their deviations from standard lines. Only $P_{g,F}$ and $\Delta P_{g,F}$ are common for all glass manufacturers. The number of relative partial dispersions given in the data sheets of different glass manufacturers and the reference spectral lines used vary considerably. For easier cross referencing, the following set of partial dispersions and their deviations from the normal lines will serve: $P_{i,g}$, $P_{g,F}$, $P_{F,e}$, $P_{e,C}$, $P_{C,s}$ and $P_{C,t}$ and $\Delta P_{i,g}$, $\Delta P_{g,F}$, $\Delta P_{F,e}$, $\Delta P_{e,C}$, $\Delta P_{C,s}$ and $\Delta P_{C,t}$. These spectral line combinations are selected to cover the yellow to blue-violet and yellow to red ranges in a balanced way. The proposed chapter also contains the equations for all normal lines of the spectral line combinations together with calculated examples.

Table 3: Tolerances for principal refractive index (original table number 1 in ISO 12123).

Grade NP	Principal refractive index tolerance limits
200	± 0.0020
100	± 0.0010
50	± 0.0005
30	± 0.0003
20	± 0.0002
10	± 0.0001

Table 4: Tolerances for refractive index variation within a delivery lot (original table number 2 in ISO 12123).

Grade NV	Refractive index variation tolerance limits
30	$\pm 30 \times 10^{-5}$
10	$\pm 10 \times 10^{-5}$
5	$\pm 5 \times 10^{-5}$
2	$\pm 2 \times 10^{-5}$

Table 5: Tolerances for the Abbe number (original table number 3 in ISO 12123).

Grade AN	Abbe number tolerance limits
8	$\pm 0.8\%$
5	$\pm 0.5\%$
3	$\pm 0.3\%$
2	$\pm 0.2\%$
1	$\pm 0.1\%$

Table 6: Tolerances for the homogeneity of optical raw glass.

Grade NH	Homogeneity tolerance limits (peak-to-valley)	Generally applicable for
100	100×10^{-6}	Common application sizes
40	40×10^{-6}	
10	10×10^{-6}	Partial volumes of the raw glass
4	4×10^{-6}	
2	2×10^{-6}	Partial volumes of the raw glass but not for all glass types
1	1×10^{-6}	

The relevant sub-aperture size can be given in brackets e.g. (50 mm or r30 mm×50 mm rectangular) (original table no. 4 in ISO 12123).

Table 7: Striae wavefront deviation tolerances (Extension +2 or +3 indicates inspection in two or three rectangular directions).

Grade SW	Traditional US striae grade	Striae wavefront deviation tolerance limit per 50 mm path length (nm)	Generally applicable for
60	D	<60	Raw glass
30	C	<30	Partial volumes of the raw glass
15	B	<15	
10	A	<10	

Table 8: Bubbles and inclusions within optical raw glass – permissible cross section (original table number 6 in ISO 12123).

Grade IS	Maximum permissible cross section of any bubbles and inclusions (mm ² per 100 cm ³) in a given glass volume
50	0.5
25	0.25
10	0.1
3	0.03

Table 9: Bubbles and inclusions within optical raw glass – maximum allowed number (original table number 6 in ISO 12123).

Grade IN	Maximum allowable number (per 100 cm ³)
140	140
70	70
30	30
10	10

Any combinations of the grades IS and IN are possible.

Table 10: Stress birefringence tolerance limits for optical raw glass (original table number 7 in ISO 12123).

Grade SB	Stress birefringence tolerance limits (nm/cm)	Generally applicable for
–	≥20	Raw glass
20	<20	
12	≥12	
6	≤6	
4	≤4	Cut parts from the raw glass
2	≤2	

4.2 Proposed grade indications for the tolerance ranges

The grade tables of all tolerated characteristics will contain indications as shown in Tables 3–10. All indications refer to the numbers of the limit values. The grade indications for the principal refractive index and its variations in delivery lots are equal to the mantissa of the limits when they are expressed using the fifth negative power of 10, 10⁻⁵. For homogeneity, the power of 10 used is 10⁻⁶, for the Abbe number, 10⁻¹, and for the cross section of bubbles and inclusions, 10⁻². For the grades of the characteristic striae, the number of bubbles, and stress birefringence, the limit values are used directly. The table of striae grades additionally contains the traditional US indications, which correspond to the wavefront grading quite well.

For the principal refractive index (Table 3) and the Abbe number (Table 5) additional narrower grades have been proposed extending each table by one line.

The existing example has been extended and transferred into the new grade indications

Example: Schott N-BK7

$n_d = 1.51680 \pm 0.0010$; lot variation: $\pm 10 \times 10^{-5}$

$v_d = 64.17 \pm 0.5\%$

Inclusions: 0.1 mm²/100 cm³, 30/100 cm³

Partial volume size 30 mm×50 mm:

Optical homogeneity: 4×10^{-5} (pv)

Striae: 15 nm two directions

In grade indications, these specifications read

NP 100/NV 10/AN 5/NH 40 (r30 mm×50 mm)/SW 15+2/IS 10/IN 30/SB 6

4.3 Other changes

In the definitions of transmittance, internal transmittance, and spectral internal transmittance, it has been proposed to replace the expression ‘luminous flux’ by ‘radiant flux’. Luminous flux implies weighing of the transmittance with the spectral sensitivity of the human eye. This is wrong in this context.

Other significant changes besides typing errors have not been proposed.

5 Measurement and inspection standards

In the past, standardization of measurement standards for optical glass concentrated itself on properties typical for specific glass types in Table 11 called generic properties. They are measured once after the development of a glass type. Their variations from melt to melt are far smaller than the accuracy of the methods.

With ISO 11455, only one quality inspection standard existed specifying the method for routine quality inspection of stress birefringence. Since 2014, another one exists: ISO 17411 describing interferometric measurement of optical homogeneity. In preparation is a standard on the measurement of the refractive index with the minimum angle goniometer method. This method also covers dispersion properties such as Abbe number and partial dispersions because, as a rule, one measures refractive index at a set of wavelengths.

For the quality characteristics transmittance, striae and bubble and inclusion inspection standards are still missing. One reason for the lack of inspection standards is that an international specification standard did not exist until ISO 12123 was published in 2010. There was

no common basis of agreed definitions and minimum requirements to which inspection standards could refer. Additionally, the definitions were in very different stages. Refractive index is a well-defined physical quantity since hundreds of years, striae on the other side were phenomena in glass, which had been inspected by visual comparison with reference striae. But there was no physical quantity related to them. So no method existed for quantitative detection and, hence, also for the appraisal of their effects in optical imaging. Before a standard could be formulated, considerable research was needed. Even for a quantity such as optical homogeneity with a definition as simple as ‘maximum variation of the refractive index’, a closer look shows the need for more specific regulations.

5.1 Comments on inspection standards for the specification characteristics of optical glass

Refractive index and dispersion The refractive index and its dependence on wavelength (dispersion) are well-defined physical properties. There are several methods for measurement available: The refractometers according to Abbe and to Pulfrich, both using the critical angle of total internal reflection, the v-block method, a differential method measuring the difference of the refractive indices of the sample and a reference prism, and the minimum angle goniometer method directly measuring the refraction angle. The methods increase in accuracy from about 1×10^{-4} to 1×10^{-6} and in costs per measurement in the order as they are mentioned. The goniometer method is subject of the inspection standard being prepared presently. It requires precisely made prisms with optically polished surfaces, a very precise goniometer, and strict temperature stabilization in order to achieve best accuracy. Therefore, the standard will be used mainly as a reference method, but not in daily practice.

Optical homogeneity ISO 17411 describes the measurement of optical homogeneity. The method using a laser

Table 11: Existing measurement (generic properties) and quality inspection standards for optical glass.

ISO 8424:1996	Acid resistance	Generic property
ISO 9385:1990	Knoop hardness	Generic property
ISO 9689:1990	Phosphate resistance	Generic property
ISO 10629:1996	Alkali resistance	Generic property
ISO 11455:1995	Stress birefringence	Quality inspection
ISO 12844:1999	Grindability with diamond grains	Generic property
ISO 17411:2014	Homogeneity by laser interferometry	Quality inspection

Fizeau-interferometer with expanded beam matching the diameter of the sample is very costly. The equipment is very expensive, the interferometer room has to be highly temperature stabilized, the setup must be shielded against environmental mechanical vibrations. One method requires polished samples, another one highly polished and, thus, expensive oil-on plates. A homogeneity measurement increases glass items' prices not by percentage but by factors.

For this reason, such measurements are exceptional and done only for very critical quality requirements. Quality assurance of optical homogeneity for common optical elements is done by production process control.

For high precision measurement of refractive index, dispersion and optical homogeneity strict temperature stabilization of the equipment and especially the samples is a must. Transient temperature gradients introduce systematic errors and can hardly be separated from real variations in refractive index.

Transmittance A standard on the measurement of transmittance is still missing. For low refractive index glass types, transmittance is usually very high throughout the total visible light range. This continues also in the short wavelength infrared range. Especially for thin lenses, measurement results are not very interesting as they lie very close to the physical limit set by 1 as full transmittance together with the light losses due to reflection at the entrance into the glass and at the exit.

The region of interest is the UV-edge, the sharp drop of transmittance every glass type exhibits if one travels to

short wavelengths. The UV-edge position is mainly determined by the glass composition and the resulting refractive index and dispersion properties. Impurities in the raw materials will lower its steepness. The steepness, thus, is a quality characteristic at least partly. Information on position and steepness of the UV-edge can be given by quoting the wavelengths of a low transmittance and of a high transmittance level at a given sample thickness. This is done using the color code. Its name comes from the fact that for high refractive index glasses, the UV-edge lies partly already in the visible light range introducing a yellowish color tint.

Unfortunately, the traditional definition of the color code bases on transmittance values including reflection losses (see Figure 2). Therefore, it does not relate to practical application of optical glasses. All optical elements are anti-reflection coated, nowadays. Furthermore, glasses with high refractive index above 1.83 hardly reach the commonly used upper level of 80%. So for such glasses, the 70% level is used instead. This is only a weak remedy. The very shallow slope of the transmission curve close to this level leads to large differences in wavelength for only small transmission changes. For this reason, ISO 12123 introduced a similar quantity as the color code named UV-cutoff edge but now basing on internal transmittance. With transmittance values given in glass data sheets with three decimal places, accuracy of the measurement should lie in the fourth decimal place for transmittance and also for the reflection factor. For calculating the reflection factor with the needed accuracy, it is sufficient

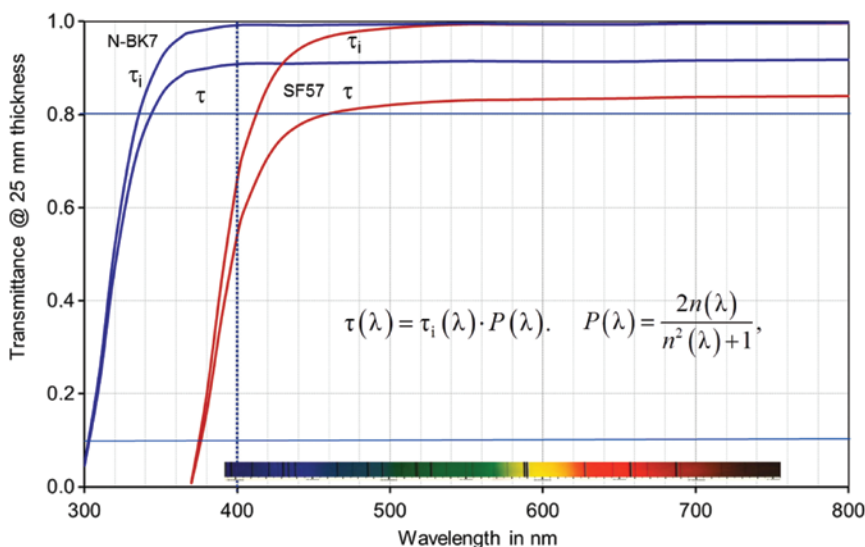

Figure 2: Transmittance (τ) and internal transmittance (τ_i) curves for two optical glasses, a low-refractive index glass N-BK7, and a high-refractive index glass SF57. P , Reflection factor; n , refractive index. The 80% and 10% lines are highlighted. The spectrum indicates the visible light range.

to know the refractive index to about 4×10^{-4} , which is not too demanding. The internal transmittance should be usable without considerable problems.

A tolerance range for the color code or the UV-cutoff edge is not really possible. The position of the edge varies over 100 nm among all optical glasses, and steepness is not only influenced by impurities but also from glass components used for achieving high refractive index such as lead, barium, niobium, titanium, and bismuth. An alternative way of tolerancing could be to put lower limits to data sheet values in the blue to ultraviolet light range. But then, the reference thickness of the sample becomes even more important because transmission depends on thickness exponentially.

Striae There have been several attempts to issue a standard about the inspection of striae. However, the experts could not agree on a common method. The test setup used is almost the same with all manufacturers. The shadowgraph method, mainly consisting of a point-like lamp and a screen with the sample in between, is very sensitive. Disagreement concentrated on the valuation of the striae patterns on the screen. The two principles, which are successfully used in daily practice are visual comparison with reference striae and visibility assessment of striae on screens with different roughness. Both methods are not very selective in discriminating striae of different strengths from each other. Relations to a physical quantity were also missing, which would have allowed appraising the striae effects in optical systems. Around 1990, the possibility came up to measure the reference striae used by SCHOTT with the needed high spatial resolution (ca. 0.1 mm) and high wavefront distortion accuracy with the interferometer DIRECT 100 by Carl Zeiss. The striae grades, which had been indicated formerly by the letters A, B, C, and D, could be expressed in wavefront distortions ca. 10, 15, 30, and 60 nm. A first relation to the requirements from optical imaging became possible by comparing the striae wavefront distortion with common specifications for the waviness of lens surfaces. The value 1/10 of the wavelength, that means about 55 nm, is close to that what glass manufacturers already call strong striae.

The reference striae existed only in one single sample. They were representative for isolated filament striae typical for clay pot molten glass, which is not produced anymore since long time for cost reasons. A glass plate with coated strips of different thickness serves as a replacement. Gaps of different widths provide edges simulating the wavefront slopes of striae (see Figure 3).

Progress in digital image processing allows making striae inspection more objective. The use of standard

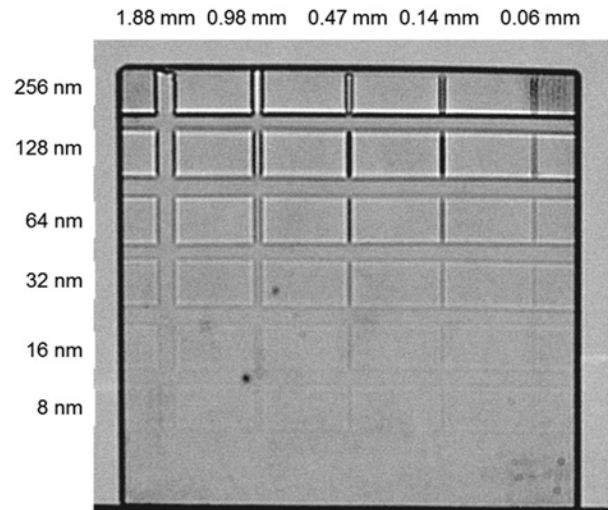

Figure 3: Striae reference plate with different wavefront steps achieved with coatings of different thickness and with gaps of different width.

commercial equipment led to reproducibility of 10% and better for striae strength in grayscale patterns. The measurement of the reference striae plate revealed a fundamental problem overlooked or ignored in the past, however. The correlation between shadow contrast and wavefront distortion is not unique. Diffraction also influences the patterns on the screen of the shadowgraph method. Different combinations of wavefront steps with gap widths can lead to the same contrast.

Investigations revealed a way to remove this ambiguity by combining the position of the first diffraction minimum [6] with contrast. The evaluation method is now implemented in image processing software [7].

The ISO working group agreed to draft a new standard for striae inspection following this approach.

Bubbles and inclusions The inspection of bubbles and inclusions uses a very simple setup (Figure 4). The illumination of the samples comes from the side. A black background makes bubbles and inclusions visible so that they can be counted easily. Long distance microscopes enable size measurement. The use of strong lamps can

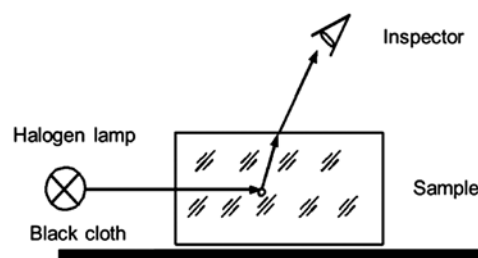

Figure 4: Inspection setup for bubbles and inclusions.

introduce a problem. Tiny inclusions in the size range, which is below the registration limit of 30 μm , look much bigger than they really are. So glass might be rejected, which would be perfectly usable in optical systems. Only for a system transmitting very high intensity light such as high-power laser light, such inclusion may be critical. A future standard should set an upper limit for the inspection light intensity.

Stress birefringence ISO 11455 ‘Determination of birefringence’ describes the method according to de Sénarmont and Friedel. It converts the wavefront retardation between two perpendicularly polarized light rays into a rotation angle, which can be measured easily. The prescribed measurement positions lie close to the edges of the sample. Together with normal light incidence, this reduces the stress tensor to its tangential vector. The interpretation of stress content becomes much easier. Since about 15 years, measurement setups are available employing this method simultaneously for many pixels across the total area of the test sample. This has improved accuracy and the overview image of the birefringence distribution considerably. These images, however, do not relate to the stress distribution in the sample in an easy way anymore.

The standard ISO 11455 describes the fundamental method very clearly. It can be applied without expensive equipment. Therefore, the standard will be kept unchanged.

5.2 Optical glass test standards

The Knoop hardness test standard ISO 9385 is well established and will be extended without changes most probably.

This also holds for the chemical resistance standard ISO 9689 ‘Resistance to attack by aqueous alkaline phosphate-containing detergent solutions at 50°C – Testing and classification.’

The objective of the standard ISO 12844 ‘Grindability with diamond pellets – Test method and classification’ is to provide a measure for ranking glass types according to their behavior in the grinding process. The volume reduction while grinding samples with a specific tool is related to that of a reference glass type. The use of the grindability classification of optical glasses seems to be very poor. This standard is under observation if it is to be withdrawn.

A new classification standard is under preparation, which will specify the water resistance of optical glass by the powder method. Glass will be crushed down to about 0.5 mm grain size. The weight loss after boiling will be

used to rank the glass type within a given set of resistance classes.

6 The material specification standard for optical elements ISO/WD 10110 part 18

ISO standard working draft ISO/WD 10110 – 18 ‘Optics and photonics – Preparation of drawings for optical elements and systems – Part 18: Material Imperfections – Stress Birefringence, Bubbles and Inclusions, and Homogeneity and Striae’ is meant to be in harmony with the raw optical glass standard ISO 12123. The indications for the characteristics stress birefringence, bubbles and inclusions, optical homogeneity and striae shall be backward compatible in order to avoid changes of existing optical element drawings. They are intended to take into account progress made with the specification of raw optical glass. The user should be supported to find the specification level needed for the functional requirements while avoiding overspecification at the same time. Otherwise, this could lead to unnecessarily high costs and delivery problems due to restricted availability of high-quality glass or to additional inspection effort.

The draft standard as it is proposed presently introduces a method to specify raw glass for an optical element additionally to that of the element itself. For elements with low requirements, the new optical glass default quality makes specification very easy. The annex aims to give further guidance for best quality level selection.

6.1 Indications

All indications of the ISO 10110 series consist of a leading number encoding the characteristic a slash and the specification code (see Figure 5). For stress birefringence, no changes are intended. As an example, the indication may be 0/12 with 0 for stress birefringence and 12 for the maximum allowed optical path difference of 12 nm/cm. Bubbles and inclusions encoded by the number 1 will not be changed also most possibly.

The main changes are planned with striae and optical homogeneity. The old specification will be kept for backward compatibility. It classifies striae according to the area share they cover in a finished element if they are stronger than 30-nm optical path difference. There are doubts if such appraisal of finished elements of optical glass ever

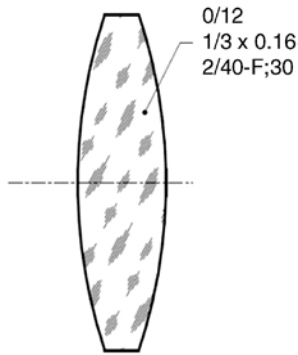

Figure 5: Indication example.

has been done in practice. The new specification will use optical path difference per geometrical light path in accordance with ISO 12123. If there is a need for requiring striae quality in one or two directions perpendicular to the main direction, this can be denoted directly in the indication. Striae indication always appears in combination with optical homogeneity indication. The code is 2. First comes homogeneity and then striae: Using the traditional class specifications, this could be 2/1;1, for example.

Striae indications may look as follows (homogeneity represented here by a dash): 2/-;2 with the old striae class 2 or 2/-;(30), +2 meaning 30 nm optical path difference per 50 mm in two perpendicular directions. The brackets mean that the number gives the optical path difference in nanometer. The reference glass thickness is 50 mm.

Optical homogeneity may be indicated in two different ways also. One can use the old class indicators or the refractive index variation (peak-to-valley) directly in unit 1×10^{-6} . The 2/1;- uses the old class 1 representing 40×10^{-6} . The 2/(40);- will mean the same. The indication can be extended by a '-F' allowing subtraction of the focus term in homogeneity inspection. This part of homogeneity is usually negligible in application but may decide about meeting the specification or not.

If the raw glass shall be specified for an element the characteristics it is proposed to extend, the encoding number is by a leading '0'. For example, 02/(30);(40) specifies the striae optical path difference of 30 nm/50 mm and homogeneity 40×10^{-6} . The specification is meant to be interpersted as follows: If the raw glass already fulfills these requirements, it is accepted to be used for the elements.

For small and thin lenses, the quality of optical glass is usually suitable without the need for specific requirements. In such case, a dash may be used as specification indicator. This will mean 'default quality', which is listed in ISO 10110 part 11 'Non-toleranced data'.

6.2 Annexes with guidance information

The present working draft ISO/WD 10110 – 18 contains six annexes, which serve the user to find the best way to specify optical elements. The first two are a reference to the characteristic grades defined in ISO 12123 and an explanatory text about the stress optical constant.

Four annexes provide specification limits proven in practice for typical optical applications for the different characteristics. The sizes of the elements play an important role in choosing specification tolerances. For small lenses, specifications may rely totally on default quality. The larger, especially the thicker, the elements become, the more carefully specifications have to be considered. Each characteristic behaves differently with increasing element thickness. Another important aspect is the relation between the size of the finished element with respect to that of the raw glass item from which it will be made. This can be one to one for large optical lenses and >1000 to one for small lenses made from strip glass.

Stress birefringence in lenses with 5 mm thickness or below can be neglected totally. For thicker lenses, it becomes more and more difficult to achieve low stress birefringence. For glass items, fine annealed with the same annealing rate, stress birefringence rises approximately with thickness square. This is due to the fact that glass is a low-temperature conducting material. As a consequence, stress birefringence limits must be set for larger items. This will lead to lower allowed annealing rates. If the limits are set too low, this will cause long dwell time in the furnace, thus, increasing costs and delivery time [8].

On the other hand, if small items are not annealed with their final thickness but cut from a fine annealed large glass block or strip, another consideration may avoid overspecification. It is not necessary to require the stress birefringence level needed in the final small element to be fulfilled already with the large preform item. Just cutting large items down to small ones reduces mechanical stress considerably. Hence, also birefringence collapses usually much stronger than linearly.

It is intended to state that bubbles and inclusions can be specified with 1/0. That means none is allowed at all. This works fine with small lenses. Some few bubbles in strip glass will reduce lens yield only slightly. For larger lenses, the probability rises that a bubble will remain in the volume. Discarding such lenses may reduce yield too much. Then, a limited number of bubbles has to be accepted.

For large lenses, the raw glass item will be not much larger than the lens itself. Usually, there is some room for optimizing the position within the raw glass item, from which the lens will be cut out. This may improve bubble

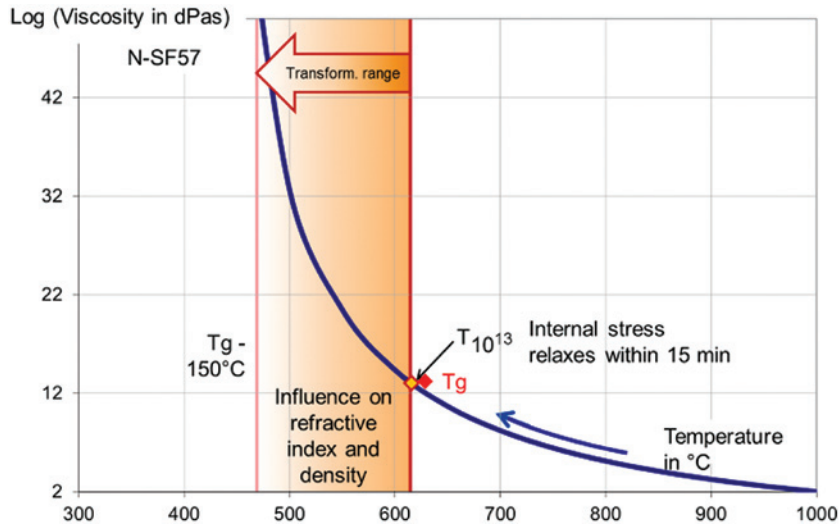

Figure 6: The cooling rate while crossing the transformation range determines essential properties of optical glass such as density and as consequence refractive index. Thermal gradients in the glass volume lead to spatial variation in refractive index and, thus, inhomogeneity. They also cause permanent residual stress at room temperature.

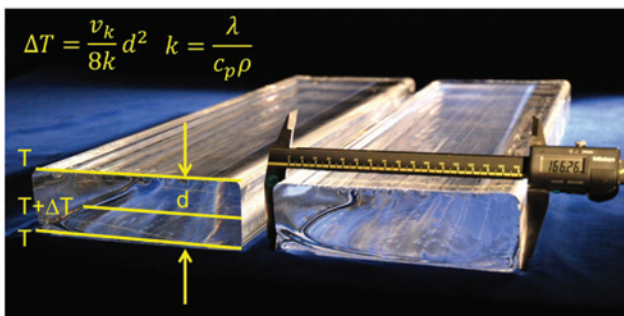

Figure 7: Thermal gradients depend on thickness square in the model of infinite plates. For low-temperature conducting materials such as glass (low k -value), special care has to be taken to keep them lowest possible while still achieving reasonable tempering periods.

quality. For such items, however, bubble specification should be determined carefully.

The annex will give guidance for choosing the maximum bubble size following a Renard 5 sequence. Each step to the next larger bubble size increases stray light by the factor 2.5.

For optical homogeneity thickness, dependence is similar to that of stress birefringence. Thin lenses are expected to have high homogeneity because hardly any significant temperature gradients can occur within thin volumes. Refractive index change with time is kept low with continuous tank melting processes. Casting times of small items are so short that it does not play any role. Moreover, even if thin lenses would have only moderate homogeneity, the wavefront distortion they can cause will only be small.

Inhomogeneity rises with temperature gradients occurring while crossing the transformation temperature

range in the fine annealing process (see Figure 6). These gradients are proportional to thickness square (see Figure 7). Thick elements with high homogeneity requirements need low or very low annealing rates.

A common mistake leading to overspecification is transferring homogeneity requirements on the element to the raw glass item. This holds especially when the element is much smaller than the raw glass item. Sub-apertures show much better homogeneity than the overall contingent aperture. So it is highly recommended to specify the sub-aperture size together with the optical homogeneity.

Striae wavefront distortion of 60 nm summed up along a geometrical light path in a glass of 50 mm is already of high quality. In modern glass production, striae, if existent at all, usually extend along the long axis of glass strips. In the two directions perpendicular to the long axis, there are hardly any striae existent as a rule. The wavefront distortion of striae along the strip axis is roughly proportional to the strip length. Thus, 60 nm/50 mm striae in a 5-mm lens are far below any concern. A lens must be already quite thick until special specification becomes necessary. With prisms, the situation is different. Within prisms, light travels along long geometrical paths. This requires striae specification to be considered carefully.

The proposed annexes divide lenses in small, medium sized, and large for addressing different specification recommendations presently without providing size limits in numbers. As a guideline, the sizes may be subdivided according to Table 12.

For small elements, in most cases, default quality will be acceptable. With medium-sized elements, specific

Table 12: Rough size ranges of optical glass items leading to different specification recommendations.

	Diameter/maximum edge length (mm)	Thickness (mm)
Small lens	<30	<5
Medium sized lens and prism	10–100	5–20
Large lens and prism	>100	>20

tolerance limits may become necessary; for large elements, they will be mandatory.

7 Conclusion

Considerable progress in specification of raw optical glass and optical elements is going on. ISO 12123 has established itself as a raw optical glass standard and shows potential for further improvement. The standard for indications in drawing for optical elements ISO 10110 is planned to be put in harmonization with the raw glass standard. General information will support users for suitable tolerance selection. The test and inspection standards have overcome a period of stagnation and are now moving forward heading to a complete set covering all specification characteristics.

Acknowledgments: The author thanks Mareike Trunk and Uwe Petzold for reading the manuscript and giving valuable feedback.

References

- [1] P. Hartmann and R. Jedamzik, Proc. SPIE 7102, 71020L (2008).
 [2] P. Hartmann, Opt. Eng. 54(10), 105112-1–105112-8 (2015).

- [3] H. J. Hoffmann, W. W. Jochns and G. Westenberger, Proc. SPIE 1780, 303–314 (1992).
 [4] H. J. Hoffmann, Journal de Physique IV Colloque C2 Supplement au Journal de Physique III, 2, C2-21–C2-30 (1992).
 [5] M. Englert, P. Hartmann and S. Reichel, Proc. SPIE 9131, 91310H (2014).
 [6] H. Gross, M. Hofmann, R. Jedamzik, P. Hartmann and S. Sinzinger, Proc. SPIE 7389, 73891C (2009).
 [7] C. Lempa, Charakterisierung und Messung von Schlieren in optischem Glas mittels Bildverarbeitung, Master thesis, University of Applied Sciences Darmstadt (2014).
 [8] P. Hartmann, in ‘Optical Glass’ (SPIE Press, Bellingham Washington, 2014).



Peter Hartmann
 SCHOTT AG, Advanced Optics
 Hattenbergstraße 10, Mainz 55122, Germany
peter.hartmann@schott.com

Peter Hartmann is the Director of market and customer relations at SCHOTT AG, Mainz, Germany. He graduated in Physics with a doctoral thesis on the development of high-energy photon scintillation glasses at Max-Planck-Institute and University of Mainz in 1983. He joined the SCHOTT Optics Division in 1985 and worked in the field of quality assurance and product application of optical glasses and zero expansion glass ceramic Zerodur. He was involved in a number of major telescope projects (CHANDRA, ESO-VLT, KECK, GRANETCAN, AEOS Maui, TNG Padua, VISTA, SST) and the development of i-line glass for Microlithography. Peter Hartmann served as member of the Board of Directors of SPIE from 2011 to 2013. Peter Hartmann is convener of the working group ISO TC172/SC3/WG1 and project manager and author for ISO 12123. Furthermore, he is a guest member of the working group ISO TC172 /SC1/WG2 (ISO 10110-18).