

CALCULATION AND ANALYSIS OF HORIZONTAL AND VERTICAL LAPPING ANGLES IN TRICOT WARP KNITTING

Lingjie Zhang, Xuhong Miao, Ailan Wan

Engineering Research Center for Knitting Technology, Ministry of Education, Jiangnan University, Wuxi, Jiangsu 214122, China

Abstract:

The lapping angle, which affects the style and quality of production, has been studied as a parameter of weft knitting. But the importance of the lapping angle has not been considered during the warp-knitting cycle. This paper shows that the lapping angle exists in the process of warp knitting and can be divided into horizontal and vertical lapping angles. Models for the lapping angles of closed and open loops were devised, and the lapping angles (horizontal and vertical lapping angles) of closed and open loops were calculated and analyzed. Furthermore, the paper seeks to investigate the factors that influence the lapping angle of tricot warp-knitted fabrics and summarize the rules. Moreover, the vertical lapping angle can affect the loop coverage. Results reveal that the decrease in number of underlaps and an increase in take-off density enables loops of the front guide bar to show on the face of the fabric. Moreover, it is also advantageous for an apparent front loop visibility when the front guide bar knits in open loop.

Keywords:

warp knitting, lapping angle, underlap, guide bar

1. Introduction

A large amount of work has been carried out to study the stages of the warp-knitting cycle and the cooperation among the knitting elements [1-3]. Almost none of these studies discusses the lapping angle during the warp-knitting cycle. There are also many reports on the lapping angle, which is divided into the horizontal lapping angle and the vertical angle during the weft-knitting process [4, 5]. The lapping angle is used as a parameter to adjust the machine so that the machine is at the best condition for production. To some extent, the warp-knitted fabric is similar to the plating stitch. However, the overlap and underlap present during the knitting cycle and the two kinds of loop (open and closed loops) distinguish weft-knitted fabrics from warp-knitted ones [6]. This paper reveals that there is a lapping angle during the warp-knitting cycle, which also can be divided into horizontal and vertical lapping angles. Moreover, it is generally acknowledged that by ensuring a larger horizontal lapping angle for the ground yarn, as opposed to the supply yarn, the front yarn will surely show on the face side of the fabric when weft knitting in plating stitch [7-9]. The principle of warp knitting involves the yarn of the front bar covering that of the back bar in a relationship of loops of the two guide bars, usually referred as loop coverage [10]. However, various factors in actual production lead to variations in loop coverage. If the yarns of the two bars are the same, loop coverage will not affect the fabric style; otherwise, it will impact the style and the quality of the product regardless of the linear density, composition, or color. A previous study has shown that a lower lapping height is considered to provide favorable conditions for the yarn to show on the face side of the warp-knitted fabric [1] and that the vertical lapping angle is related to the lapping height.

This paper aims to establish the theoretical models of closed and open loops, and it reveals that there is a lapping angle during the warp-knitting cycle, which also can be divided into horizontal and vertical lapping angles. Through the study of the lapping angle during the warp-knitting cycle, this study can provide the theoretical basis for the study on loop coverage.

2. Calculation of lapping angle

The trail of the guide needle establishes the models for the lapping angle of closed and open loops [11].

2.1. Calculation of lapping angle for closed loop

The top view of lapping movement of closed loop is shown in Figure 1, the vertical lapping angle is shown in Figure 2, and the top view of lapping movement of the open loop is shown in Figure 3, where:

- t is the needle gauge,
- r is the radius of needle bar,
- n is the maximum distance of guide needle swing toward the front of machine,
- m is the maximum distance of guide needle swing toward the rear of machine,
- c is the height of each course,
- k is the number of underlaps (Figures 1 and 3 show the case for $k=1$),
- h is the height from the contact point of the old loop and needle to the guide needle role (The value of h varies with the swing, but the amount of change is too small to be ignored),
- O_1 and O_2 are the centers of the two needles and O_1 is the coordinate origin,
- A is the origin of the new extension cord,

$B_i (i=1,2,\dots,8)$ is the tangent point between yarn and needle bar,
 $C_j (j=1,2,\dots,8)$ is the lapping point,
 $O_1E = O_2A = c-r$,
 $l_1 = k \cdot t$,
 $F_i (i=1,2,\dots,8)$ is the location of the guide needle (points F_1, F_2, \dots, F_8 are eight locations at different times), and the coordinates of F_i are (x, y) ,
 S is the total movement length of guide needle, and D is the origin point of the movement of guide needle; so $S = (x - xD) + (yD - y) = x + n - y (x > 0)$ and $S = (xD - x) + (yD - y) = -x + n - y (x < 0)$.

During the knitting cycle, the tension on the yarn makes the length of segment $AF_i' (i=1,2,\dots,8)$ the shortest, even if there is the angle of wrap between the yarn and the needle bar. Figure 2 shows the situation when the yarn is straightened. Here, A, C_i' , and F_i' are the points on the yarn, and C_i, F_i are the projections of C_i' and F_i' on the horizontal section.

$\alpha_i (i=1,2,\dots,8)$ is the horizontal lapping angle, meaning the angle between the projection of yarn on the horizontal section and the X-axis.
 $\beta_i (i=1,2,\dots,8)$ is the vertical lapping angle, meaning the angle between the yarn and the horizontal section.
 $\theta_i (i=1,2,\dots,8)$ is the yarn angle around the needle.

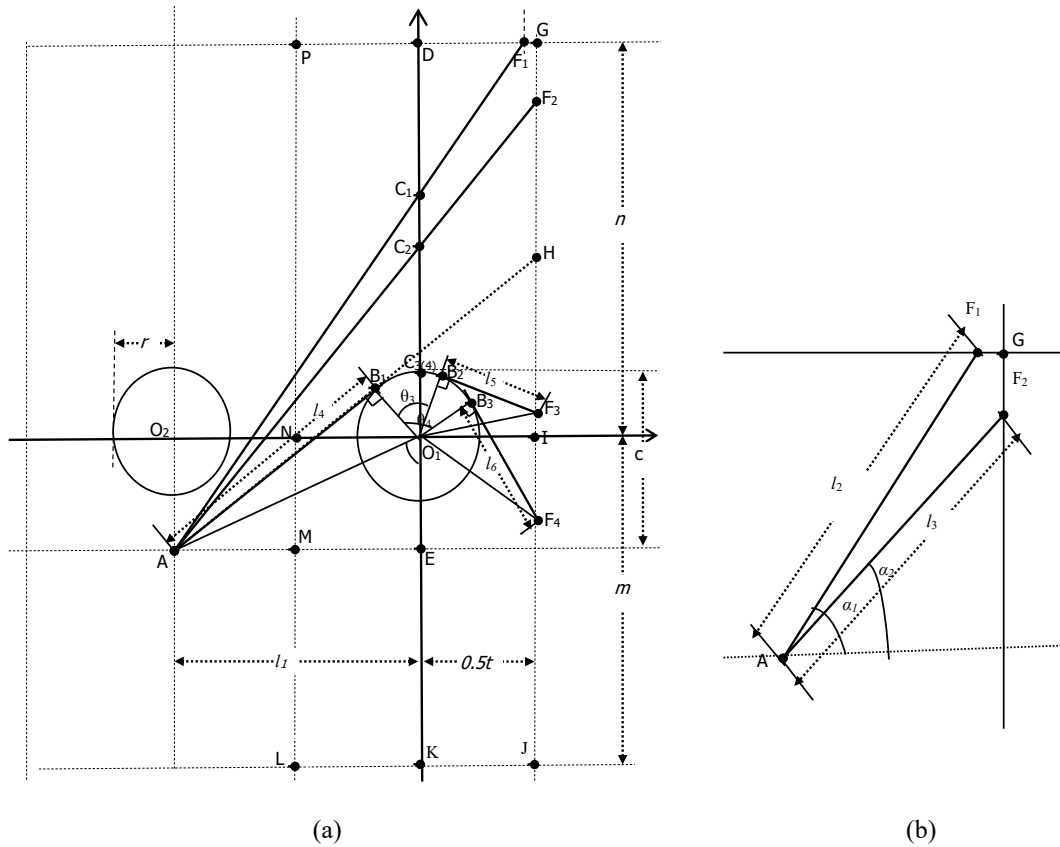

Figure 1 Top view of the lapping movement of closed loop: (a) complete lapping movement; (b) detail of lapping movement

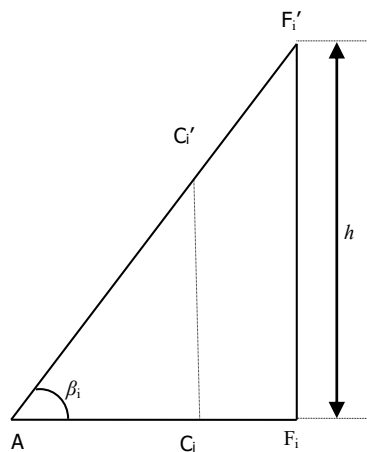

Figure 2 Vertical lapping angle

The calculation was made based on the process of D-G-H-I-J for the closed loop. There is no angle of wrap during the process D–G. The guide needle F moves between D and G, as in F_1 . Thus, $x \sim [0, 0.455]$, $y = n$, so $S = x$.

$$\alpha_1 = \arctan \frac{c - r + y}{x + l_1} = \arctan \frac{c - r + n}{S + kt} \tag{1}$$

$$\beta_1 = \arctan \frac{h}{l_2} = \arctan \frac{h}{\sqrt{(S + kt)^2 + (c - r + n)^2}} \tag{2}$$

$$\theta_1 = 0 \dots \dots \dots \tag{3}$$

There is no angle of wrap during the process G–H. The guide needle F moves between G and H, as in F_2 . Thus, $x = 0.5t$, $y \sim [y_D, n]$, so $S = 0.5t + n - y$.

$$\alpha_2 = \arctan \frac{c - r + y}{x + l_1} = \arctan \frac{c - r + 0.5t + n - S}{0.5t + kt} \tag{4}$$

$$\beta_2 = \arctan \frac{h}{l_3} = \arctan \frac{h}{\sqrt{(0.5t + kt)^2 + (c - r + 0.5t + n - S)^2}} \tag{5}$$

$$\theta_2 = 0 \tag{6}$$

The angle of wrap exists during the process H–I. The guide needle F moves between H and I, as in F_3 . Thus, $x = 0.5t$, $y \sim [0, y_D]$, so $S = 0.5t + n - y$.

$$\alpha_3 = 0 \tag{7}$$

$$\theta_3 = \frac{3\pi}{2} - \arctan \left(\frac{kt}{c - r} \right) - \arccos \left(\frac{r}{\sqrt{(c - r)^2 + (kt)^2}} \right) - \arctan \left(\frac{0.5t + n - S}{0.5t} \right) - \arccos \left(\frac{r}{\sqrt{(0.5t + n - S)^2 + (0.5t)^2}} \right) \tag{8}$$

$$\beta_3 = \arctan \left(\frac{h}{l_4 + r \times \theta_3 + l_5} \right) = \arctan \left(\frac{h}{\sqrt{(c - r)^2 + (kt)^2 - r^2} + r \times \theta_3 + \sqrt{(0.5t + n - S)^2 + (0.5t)^2 - r^2}} \right) \tag{9}$$

There is the angle of wrap during the process I–J. The guide needle F moves between I and J, as in F_4 . Thus, $x = 0.5t$, $y \sim [-m, 0]$, so $S = 0.5t + n - y$.

$$\alpha_4 = 0 \tag{10}$$

$$\theta_4 = 2\pi - \arctan \left(\frac{kt}{c - r} \right) - \arccos \left(\frac{r}{\sqrt{(c - r)^2 + (kt)^2}} \right) - \arctan \left(\frac{0.5t}{-(0.5t + n - S)} \right) - \arccos \left(\frac{r}{\sqrt{(0.5t + n - S)^2 + (0.5t)^2}} \right) \tag{11}$$

$$\beta_4 = \arctan \left(\frac{h}{l_4 + r \times \theta_4 + l_6} \right) = \arctan \left(\frac{h}{\sqrt{(c - r)^2 + (kt)^2 - r^2} + r \times \theta_4 + \sqrt{(0.5t + n - S)^2 + (0.5t)^2 - r^2}} \right) \tag{12}$$

2.2. The calculation of lapping angle for open loop

In order to ensure convenient comparison, the lapping angles of the open loop and the closed loop are to be compared at the same time. The track of the guide needle for knitting in an open loop is D-P-N-M-L.

There is no angle of wrap during the process D–P. The guide needle F moves between D and P, as in F_5 . Thus, $x \sim [-0.5t, 0]$, $y = m$, so $S = n - x - m$.

$$\alpha_5 = \arccos \left(\frac{-x}{\sqrt{x^2 + n^2}} \right) - \arcsin \left(\frac{r}{\sqrt{x^2 + n^2}} \right) = \arccos \left(\frac{S + m - n}{\sqrt{x^2 + n^2}} \right) - \arcsin \left(\frac{r}{\sqrt{(S + m - n)^2 + n^2}} \right) \tag{13}$$

$$\theta_5 = 2\pi - \arccos \frac{r}{\sqrt{(kt)^2 + (c - r)^2}} - \arctan \frac{c - r}{kt} - \arcsin \frac{n}{\sqrt{(S + m - n)^2 + n^2}} - \arccos \frac{r}{\sqrt{(S + m - n)^2 + n^2}} \tag{14}$$

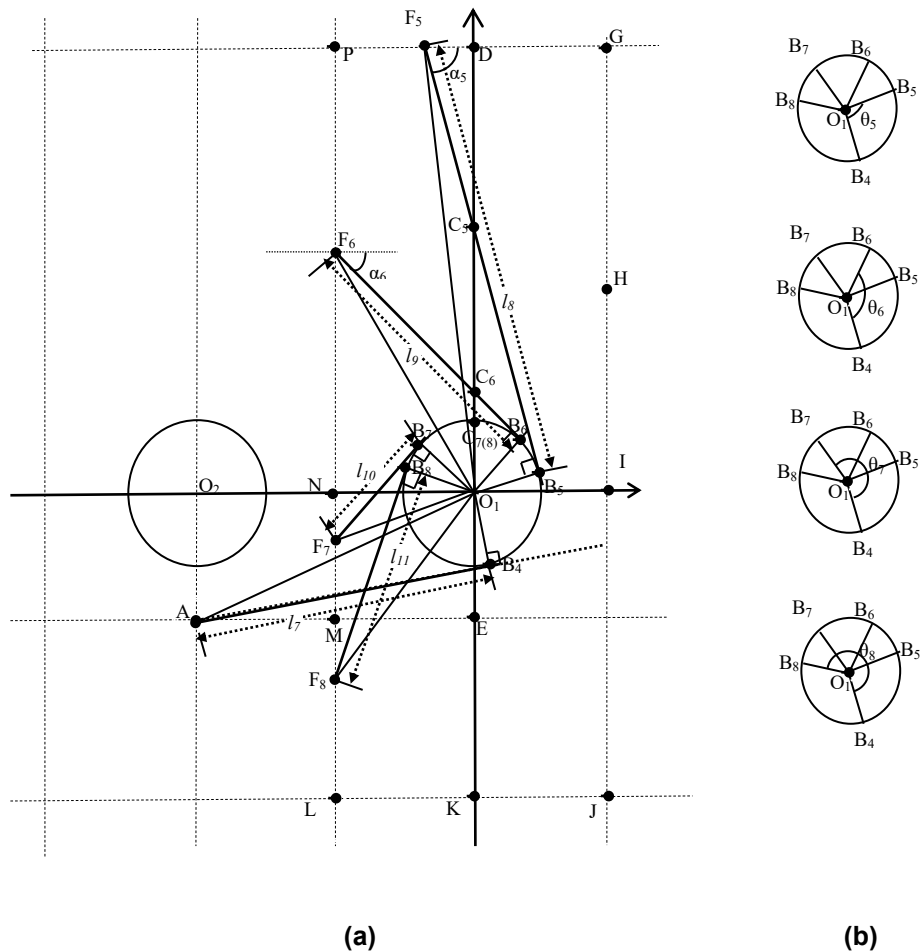

Figure 3 The top view of lapping movement of open loop: (a) the complete picture of lapping movement; (b) the detail view of the lapping movement

$$\beta_5 = \arctan\left(\frac{h}{l_7 + r \times \theta_5 + l_8}\right) = \arctan \frac{h}{\sqrt{(kt)^2 + (c-r)^2 - r^2} + \theta_5 \times r + \sqrt{(S+m-n)^2 + n^2 - r^2}} \quad (15)$$

There is no angle of wrap during process P–N. The guide needle F moves between P and N, as in F_6 . Thus, $x=-0.5t$, $y \sim [0, n]$, so $S=0.5t+n-y$.

$$\alpha_6 = \arctan \frac{y}{0.5t} - \arcsin\left(\frac{r}{\sqrt{(0.5t)^2 + (0.5t+n-S)^2}}\right) = \arctan \frac{y}{0.5t} - \arcsin\left(\frac{r}{\sqrt{(0.5t)^2 + (0.5t+n-S)^2}}\right) \quad (16)$$

$$\theta_6 = 2\pi - \arccos \frac{r}{\sqrt{(kt)^2 + (c-r)^2}} - \arctan \frac{(c-r)^2}{kt} - \arccos \frac{0.5t}{\sqrt{(0.5t)^2 + (0.5t+n-S)^2}} - \arccos \frac{r}{\sqrt{(0.5t)^2 + (0.5t+n-S)^2}} \quad (17)$$

$$\beta_6 = \arctan\left(\frac{h}{l_7 + r \times \theta_6 + l_9}\right) = \arctan \frac{h}{\sqrt{(kt)^2 + (c-r)^2 - r^2} + \theta_6 \times r + \sqrt{(0.5t)^2 + (0.5t+n-S)^2 - r^2}} \quad (18)$$

Angle of wrap exists during process N–M. The guide needle F moves between N and M, as in F_7 . Thus, $x=-0.5t$, $y \sim [-c, 0]$, so $S=0.5t+n-y$.

$$\alpha_7 = 0 \quad (19)$$

$$\theta_7 = 2\pi - \arccos \frac{r}{\sqrt{(kt)^2 + (c-r)^2}} - \arctan \frac{c-r}{kt} + \arccos \frac{0.5t}{\sqrt{(0.5t)^2 + (0.5t+n-S)^2}} - \arccos \frac{r}{\sqrt{(0.5t)^2 + (0.5t+n-S)^2}} \quad (20)$$

$$\beta_7 = \arctan\left(\frac{h}{l_7 + r \times \theta_7 + l_{10}}\right) = \arctan \frac{h}{\sqrt{(kt)^2 + (c-r)^2 - r^2} + \theta_7 \times r + \sqrt{(0.5t)^2 + (0.5t+n-S)^2 - r^2}} \quad (21)$$

There is the angle of wrap during process M–L. The guide needle F moves between M and L, as in F_8 . Thus, $x=-0.5t$, $y=-[m,-c]$, so $S=0.5t+n-y$.

$$\alpha_s=0 \tag{22}$$

$$\theta_s=2\pi - \arccos \frac{r}{\sqrt{(kt)^2 + (c-r)^2}} - \arctan \frac{kt}{c-r} + \arccos \frac{0.5t}{\sqrt{(0.5t)^2 + (0.5t+n-S)^2}} - \arccos \frac{r}{\sqrt{(0.5t)^2 + (0.5t+n-S)^2}} \tag{23}$$

$$\beta_s= \arctan \left(\frac{h}{l_7 + r \times \theta_8 + l_{11}} \right) = \arctan \frac{h}{\sqrt{(kt)^2 + (c-r)^2 - r^2} + \theta_8 \times r + \sqrt{(0.5t)^2 + (0.5t+n-S)^2 - r^2}} \tag{24}$$

3. Example of calculation and analysis

The calculation was made based on the KS2 tricot warp-knitting machine (grooved needle) made by Karl Mayer, in which the knitting gauge is E28, $r=0.25$ mm, and $t=0.91$ mm. The following are the measurements:

GB1: $m=4$ mm, $n=2$ mm, $h=14.5$ mm

GB2: $m=1$ mm, $n=5$ mm, $h=12.5$ mm

The take-off density D was designed in three forms, i.e., 16 cpc (16 courses per centimeter), 23 cpc, and 30 cpc.

$$c=10/D \tag{25}$$

By inputting the above-mentioned parameters into the S -dependent function, the lapping angle- S function can be figured out. In addition, the movement process of the guide needle is divided into sections, so that the range could be ascertained, and the range changes with parameters, such as k , n , and so on. It should be noticed here that when knitting in a closed loop, the take-off density is 23 cpc ($c=10/23 \approx 0.43$ mm) and $k=1-4$, coordinates of H as the special points are (0.455,0.514), (0.455,0.368), (0.455,0.326), (0.455,0.306). The function of y_H is shown as follows:

$$y_H = (0.5+k)t \times \tan \left(\arctan \left(\frac{c-r}{t*k} \right) + \arcsin \left(\frac{r}{\sqrt{(t*k)^2 + (c-r)^2}} \right) \right) - (c-r) \tag{26}$$

So the range of every section can be noted. The curve was constructed in Origin9.1 (OriginLab). It should be noted that the range of the function changes with the relevant parameters, such as k , n , c and so on; therefore, the range of every curve is different.

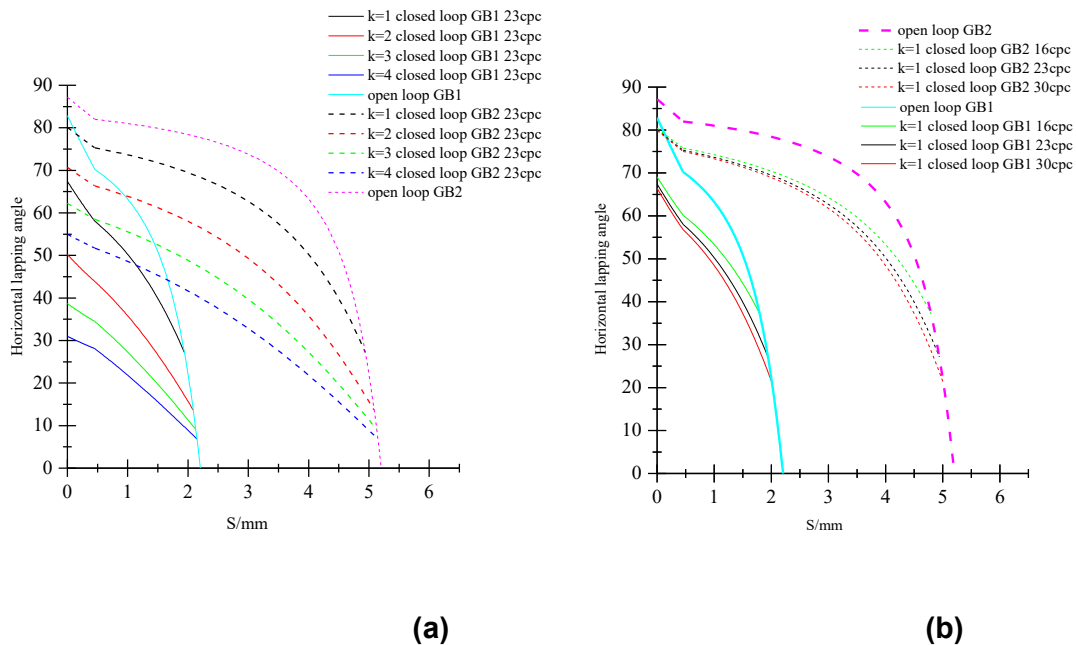
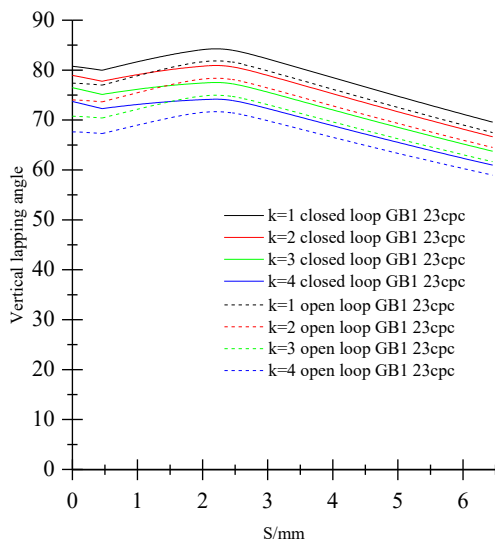

Figure 4 Horizontal lapping angle: (a) horizontal lapping angle changes with k , loop style, and guide bar position; (b) horizontal lapping angle changes with c

Figure 4(a) shows that the horizontal lapping angle decreases gradually in a knitting cycle and finally turns to zero. The trends of the front and back guide bars are similar. It also shows that the horizontal lapping angle of a closed loop decreases with the increase of k . However, regardless the front or back position of the guide bar, the horizontal lapping angle of the open loop is the same. Figure 4(b) shows that the horizontal lapping angle of both front and back bars decreases with the increase of take-off density when a closed loop is knitted. The horizontal lapping angle of the open loop remains the same. Figure 4 shows that the horizontal lapping angle of the open loop is bigger than

for the closed loop under the same condition. The horizontal lapping angle of front guide bar is always smaller than that of the back guide bar. So, the position of the guide bar is the main factor affecting the horizontal lapping angle.

Figures 5 and 6 show the same trend of vertical lapping of front guide bar and back guide bar. Vertical lapping angle of a closed loop is always bigger than that for the open loop under the same condition. Figures 5(a) and 6(a) show that the number of underlaps, k , is inversely proportional to the vertical lapping angle, whether or not it is a closed or open loop.



(a)

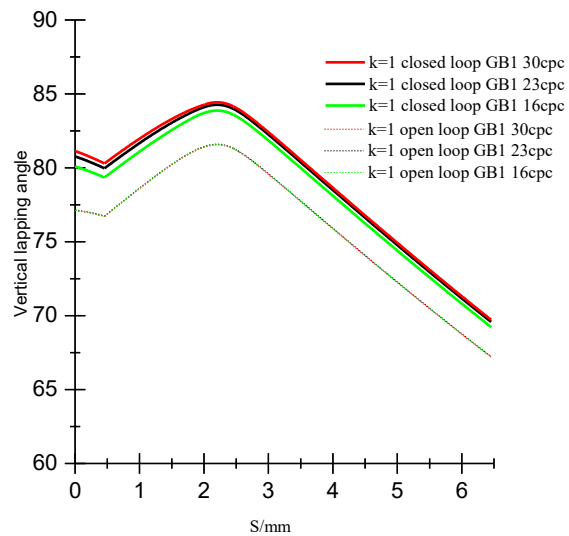

(b)

Figure 5 Vertical lapping angle of front guide bar: (a) vertical lapping angle changes with k , loop style; (b) vertical lapping angle changes with c

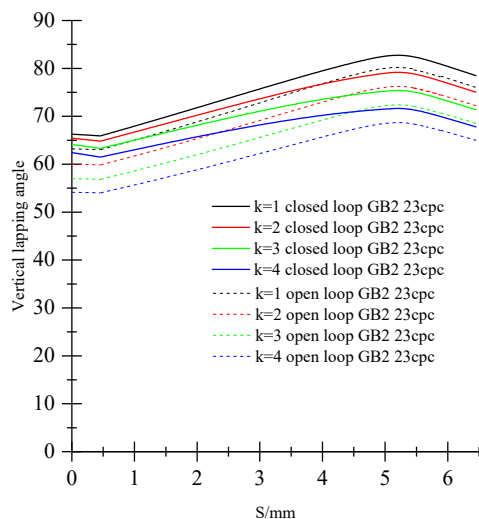

(a)

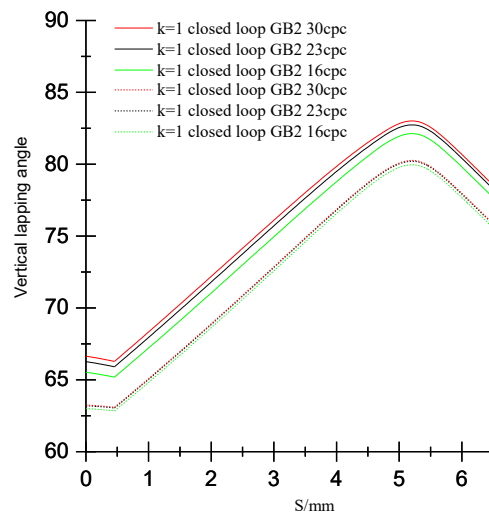

(b)

Figure 6 Vertical lapping of the back guide bar: (a) vertical lapping angle changes with k , loop style; (b) vertical lapping angle changes with c

Figures 5(b) and 6(b) show that the vertical lapping angle increases with increasing take-off density.

As shown in Figure 7, the vertical lapping angle increases from β_1 to β_2 , and the lapping height decreases from H_1 to H_2 . It can be seen that the larger the vertical lapping angle, the lower is the lapping height. Combined with the previous conclusion, the decrease of vertical lapping angle is detrimental to loop visibility on the face of the fabric.

The results show that both the horizontal lapping angle and the lapping height of an open loop increase, which is unfavorable for loop visibility on the fabric face, thereby confirming the findings in previous research. However, it was found that with an open loop, it is easier to cover other loops in practical production. To a large extent, the direction of the extension cords for the open loop make the loop expand, but for a closed loop, the direction of extension cords tends to make the loop contract.

In order to allow consistent loop coverage of the front guide bar over the back guide bar, the vertical lapping angle has an important role to play, followed by the horizontal lapping angle and the take-off density.

4. Conclusion

The investigations show that there is a lapping angle during the knitting cycle, and the lapping angle can be divided into horizontal and vertical lapping angles.

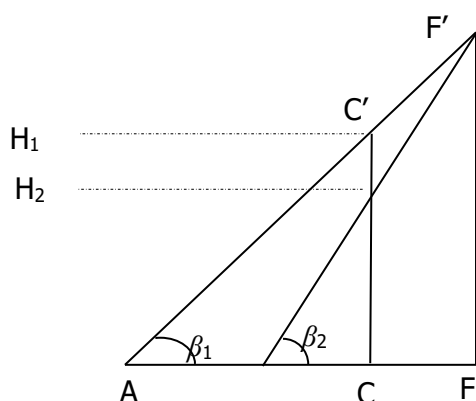

Figure 7 Vertical lapping

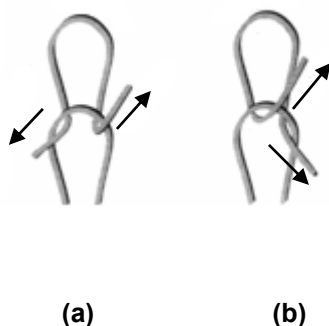

Figure 8 Warp-knitted loop: (a) the open loop; (b) the closed loop

For the closed loop, the increase of k can decrease the horizontal lapping angle and the vertical lapping angle. However, the increase of take-off density decreases the horizontal lapping angle and increases the vertical lapping angle. For the open loop, the increase of k can decrease the vertical lapping angle. The lengthwise increase of density also increases the vertical lapping angle, and the horizontal lapping angle remains the same.

Moreover, when the other parameters are the same, the horizontal lapping angle of the open loop is bigger than that of the closed loop, and the vertical lapping angle of the open loop is lower than that of the closed loop.

The lapping angle is related to the lapping height, which affects the loop coverage. The decrease of the number of underlaps and increase of the take-off density enable the front loop to show on the face of the fabric, and the front guide bar knitting in an open loop makes it easier for the loops to show on the face of the fabric.

ACKNOWLEDGMENTS

The authors acknowledge the financial support from Standard and Mode of Intelligent Manufacturing, Ministry of Industry and Information Technology of the People's Republic of China (number 1064130201160660), Innovation fund project of Cooperation among Industries, Universities and Research Institutes (CIUI), Jiangsu Province (number BY2016022-34), and the Innovation fund project of Cooperation among Industries, Universities and Research Institutes (CIURI) Jiangsu Province (number BY 2015019-01), a project funded by the Priority Academic Program Development of Jiangsu Higher Education Institutions (PAPD), and the Fundamental Research Funds for the Central Universities (JUSRP51625B).

References

- [1] Paling, D. F. (1952). *Warp knitting technology*. Harlequin Press (Manchester).
- [2] Qinglin, C. A. O. (2009). Analyzing on loop-forming motions and knitting devices of warp knitting machines. *Journal of Textile Research*, 11, 028.
- [3] Xia, F., Ge, M. (2009). Motion rule of electronically pattern system on a high speed warp knitting machine. *Fibres & Textiles in Eastern Europe*, 17(4), 75.
- [4] Xian, X. (2009). An analysis on the mechanism and knitting technology of the seamless circular weft knitting machine. *Knitting Industries*, 4, 004.
- [5] Feng, S. (2004). Study on the theory of large diameter signal plated weft knitting. *Journal of Textile Research*, 4, 020.
- [6] Raz, S. (1987). *Warp knitting production*. Melliand Textilberichte.
- [7] Zhang, L. Z., Jiang, G. M., Gao, W. D. (2009). 3-D simulation and dynamic realization of warp-knitted structure. *Journal of Textile Research*, 30(2), 125-129.

- [8] Semnani, D., Vadood, M. (2010). *Improvement of intelligent methods for evaluating the apparent quality of knitted fabrics. Engineering Applications of Artificial Intelligence*, 23(2), 217-221.
- [9] Semnani, D., Latifi, M., Tehran, M. A., Pourdeyhimi, B., Merati, A. A. (2005). *Effect of yarn appearance on apparent quality of weft knitted fabric. Journal of the Textile Institute*, 96(5), 295-301.
- [10] Renkens, W., Kyosev, Y. (2011). *Geometry modelling of warp knitted fabrics with 3D form. Textile Research Journal*, 81(4), 437-443.
- [11] Liu, X., Miao, X. (2016). *Analysis of yarn tension based on yarn demand variation on a tricot knitting machine. Textile Research Journal*, 0040517516632473.